

WALL HUNG TOILET (Combination)

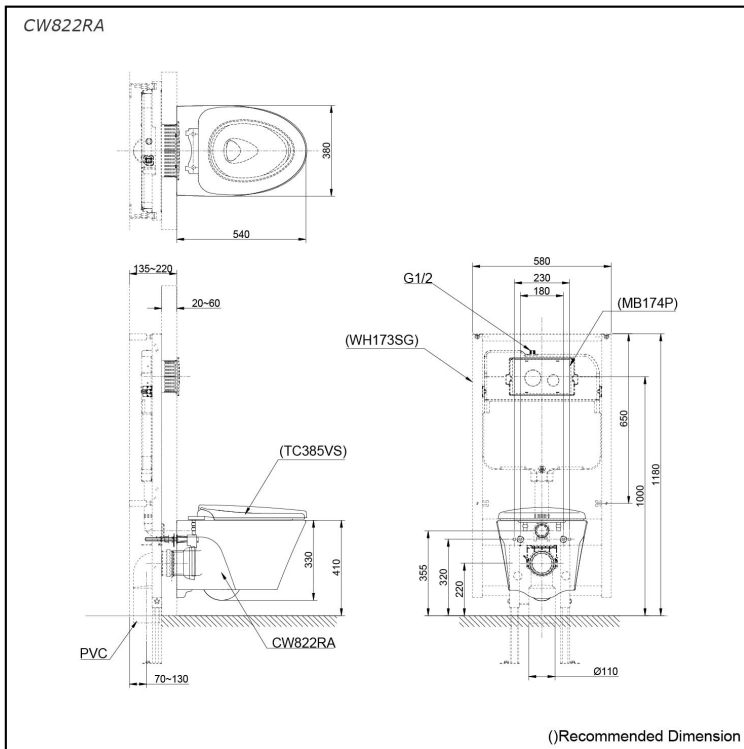

Features

- TORNADO FLUSH for powerful flushing effect with less amount of water
- CEFIONTECT Technology: super smooth, ion barrier glazing for a clean toilet bowl
- Sleek skirted design with concealed trapway for easy cleaning
- WATER SAVING structure
- RIMLESS DESIGN bowl ensures easy cleaning and ultimate hygiene
- Fully equipped with comfortable rear, front, and oscillating cleansing functions
- Adjustable warm air dryer
- Auto powerful DEODORIZER activates after every usage
- Convenient slim wireless remote, with illuminated touch pad
- Heated seat with temperature control
- Premist water is sprayed inside the toilet bowl to make it difficult for dirt to adhere
- Energy-saving function
- Easy remove for cleaning

Specifications

CW822RA:

Flush system: TORNADO FLUSH (Wash Down)

Water Use: 4.0L / 3.0L

Rough-in: H=220 mm

Bowl Shape: Elongated

Water Pressure: 0.05MPa~0.75MPa

Size: 380W x 540D x 330H mm (Toilet Bowl)

TCF6531SP:

Power Rating: 220~240V , 50/60Hz , 264~309W

Length of Power Cord: 5.0 m

Size: 390W x 531D x 188H mm (WASHLET)

Parts description

- **CW822RA**
Elongated Wall Hung Closet Bowl (P-Trap)
(Rough-in 220)
- **TCF6531SP**
WASHLET

Optional Parts

- WH173SG
Concealed Cistern w/Frame
- MB174P
Flush Panel

NOTE

- **DO NOT COUPLE THIS WC WITH FLUSH VALVE**

Colors

CW822RA
White

TCF6531SP
White

TCF6531SP

TCF6531SP

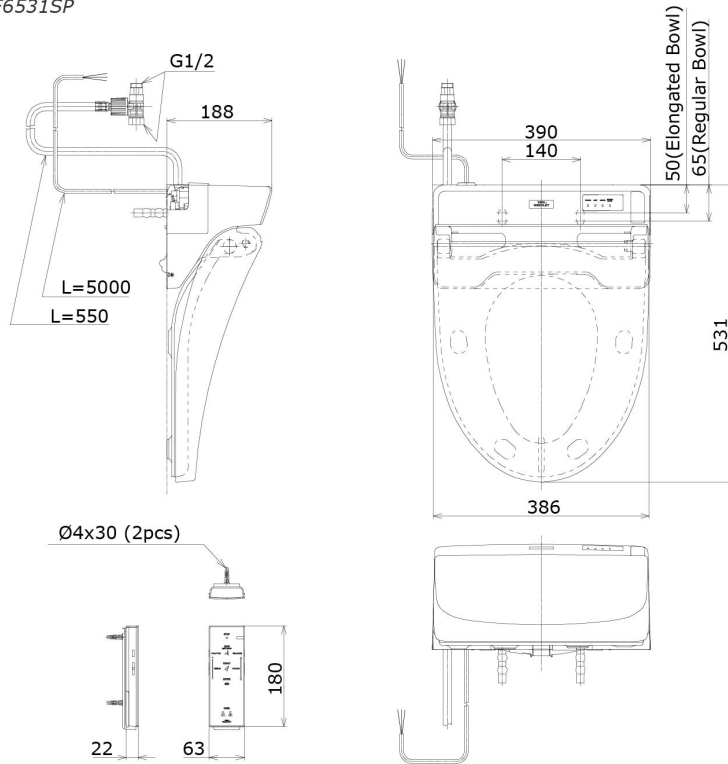

()Recommended Dimension